

# CPS-EX2000 2000W Power Supply scalable

19" embedded 2U/3U or hardmount in all positions, PFC 0,99



## Features:

- 3D-HD (3D Heat Dissipation)
- Real time C/V programming
- Real time & value C/V-monitoring
- Reference voltage f. autonomous programming
- CSB Current Share Bus
- Inhibit for safe interlocking
- Remote Shutdown
- Sense mode
- Power Good Relay DC-ok
- Precise dynamics on load change
- Series & parallel operation up to >100kW
- EMC conducted class B, radiated class A
- Efficiency 92-94%
- PFC Powerfactor 0,99
- Variable controlled fans from Papst
- Long lifetime under hard operation
- Solid 2U and 3U subframes available

Model	Voltage Prog. [V]	Current Prog. [I]
CPS-EX2000.024	24-30Vdc	42-84A
CPS-EX2000.036	30-45Vdc	28-56A
CPS-EX2000.048	45-58Vdc	21-42A
CPS-EX2000.072	58-90Vdc	14-28A
CPS-EX2000.110	90-150Vdc	9,1-18,2A



In accordance with IEC60950-1

### Technical description - a unique mechanical concept

**The Camtec CPS-EX models are high-precision industrial power supplies „Made in Germany“. These power supplies are designed for scalable power systems.**

For more than 20 years the Camtec Power Supplies manufactures high-end switch mode power supplies in Germany. A field breakdown of below 4 sigma over a 10 years period under review approves our ambitious quality concept. Each manufactured Camtec product passes several 100% random tests for each detailed function and a full-load Burn-In test.

Although it is not required from the safety norms our production applies a routine safety test to each manufactured device, even if it is an extra low-voltage model. The components in the assembled device pass stress aging to achieve an even level and to prevent from delayed failures. Our internal product engineering guidelines provide a clear target: Camtec product reputation must say „mount and forget“. Quality is never a mere promise for our team.

The CPS-EX power supplies provide low noise and ripple, a very quick programming, and an absolutely precise setting at high load changes. With an efficiency of 92-94% and a power factor of 0.99, the devices are highly energy efficient.

Equipped with high-end capacitors of outstanding lifetime our power supplies guarantee a very long and reliable operation time. The circuit design of the CPS-EX Series allows cope playing with complex loads. The internal protection circuits protect the power supply and the connected system, even in exceptional situations. The CPS-EX series is protected from high transients by strong filters with high energy efficiency. All inputs and outputs and the interface are electrically isolated. The design specifications call for the highest standards of safety and interference suppression. The device was developed in accordance with the requirements of IEC/CSA/UL60950-1 and the EMC standards EN55022 conducted Class B, radiated Class A.

**The mechanical design of the CPS-EX2000 device series is unique. It is the first power supply line in the world market, which can be flexibly adapted to any installation situation.**

The forced air cooling system with monitored and load-dependent variable fan control, allows a detached position in the system. By simple and cost-effective wall brackets the device can be integrated in any position in 90° increments. Unlike comparable power supplies Camtec comes here for the first time to let the system integrator completely free hand. The cooling concepts for supply and exhaust air can be designed to completely remove the heat dissipation from the cabinet. Complex and expensive air-conditionings for switch cabinets can be reduced to a minimum or even completely eliminate. Brackets for air channels are available as an option. In selecting the fan, as with all our power supplies, in our opinion we use with the German manufacturer EBM Papst the highest quality and most reliable devices in the world market.

The installation of the power supply in a 19" subrack is guaranteed in the simplest way. Again, our engineers have decided to offer a completely open and flexible system. The optional front panels allow the power supplies the use in either a 2U or 3U subrack. In this way we can realized 9kW in 2U-rack and up to 15kW in a 3U-rack with the CPS-EX2000 models. Up there is almost no limit: With Zero-Stacking the series allows scalable DC supplies of over 100kW in a single small 19" rack.

As accessories for the CPS-EX Camtec provides matched 19" subframes. Our subracks deserve the name of a carrier, because they really are extremely stable made of stainless steel. The power supplies have nickel-plated steel pins to position the power supplies in the subframes. The so married together systems withstand the toughest conditions. All mechanical connections in the power supplies or on the racks are constructed with A2 or nickel-plated screws, so that they provide maximum protection against corrosion and conductivity.

## Features

### Idling behavior

The CPS-EX Series is permanently open-circuit proof. When an output voltage is preset it comes stable. If a load is switched suddenly, the unit stabilized within <1ms. An overshoot of the output voltage is irrelevant.

### Start behavior

The power supply has a start delay of 1s to stabilize all measuring circuits for the interface messages accurately. The power supply starts with a ramp (soft start) of 100ms. The output voltage does not overshoot - regardless of whether a load is connected or not.

### Galvanic isolation and insulation

The switching power supply is galvanically isolated between the input and the output. All major digital inputs and outputs of the interface are electrically isolated.

### V programming (Ureg)

The output voltage of the CPS-EX power supply can be adjusted by a control signal. The setting is linear to the input signal. The power supply operates data stable even at all output voltages.

### C programming (Ireg)

The output current of the CPS-EX power supply can be adjusted by a control signal. The setting is linear to the input signal. The power supply operates data stable even at all output currents.

### V Monitor (Umon)

The power supply provides real-time monitoring of the output voltage. It is the exact and real value at the output terminals. If the sense line is used, the real value is measured directly at the load. The latency signal preset to the measured value is negligible, since the control circuit is constructed completely analogously.

### C Monitor (Imon)

The power supply provides real-time monitoring of the output current. It is the exact and real value at the output terminals. The latency signal preset to the measured value is negligible, since the control circuit is constructed completely analogously.

### Constant Voltage or Constant Current Mode (CV/CC)

The device can be operated as a DC voltage source or a constant current source. The operating mode is signaled on the interface.

### Auxiliary Voltage (AUX)

The devices feature a 12V / 500mA auxiliary voltage to operate external peripheral.

### Potentiometer Internal Control (Uadj/ladj)

If the power supply shall only set with the built in internal potentiometers, the use of the internal reference voltage is possible. The power supply requires no external signals and can operate completely autonomously.

### Potentiometer External Control (Uadj/ladj)

If the power supply shall only set with external potentiometers, the use of the internal reference voltage is possible. The power supply requires no external signals and can operate completely autonomously.

### Sense Mode

The power supply has a sense mode to compensate for voltage drops of 2V per load line.

### Fuse Mode

The unit can be operated in fuse mode. In the fuse mode, the unit is turned off and locked when it was more than 5 seconds in constant current mode to protect a connected defect load. The lock can be controlled remotely or repeal by disconnection from the mains again.

### Continuous Mode

The unit can be operated in continuous mode. In the continuous mode, the power supply provides constant current mode in a continuous flow and no ticker-operation.

### Master-Slave Mode (Ureg-Out/Ireg-OUT)

The master-slave mode can be defined in the parallel operation. One device can be set as the master, the other involved network units act as a slave and the setting signals follow current / voltage, which are commanded by the Master. This ensures that all devices are operated synchronously.

### Current Share Bus (CS)

In parallel operation, the involved network components communicate with each other and share the total power evenly to each other.

### Remote Shutdown (SD)

All CPS-EX devices have a remote shutdown (open collector or switching contacts).

### Inhibit Mode (Interlock)

The inhibit circuit reliably prevents unintentional starting of the power supply. The control loop is internally locked. Since this blocking is done progressively it is active even when the control signal, is missing due to a cable break or temporarily suspends. A premature restart of the power supply is prevented. The inhibit input can be connected to a relay or switch. If the contact is interrupted, the power supply is switched off. If the contact is closed again, the power supply restarts.

### DC and AC Fail

By DC-fail the power supply reports that the power output is disabled. By AC-fail the power supply reports an AC undervoltage. Both signals have separate outputs. Each of them can be selected between NO and NC.

### Over Voltage Protection (OVP)

On the interface is a message signal. Until the abolition of the fault the device switches off.

### Over Current Protection (OCP)

On the interface is a message signal. Until the abolition of the fault the device switches off.

### Temperature Control (TEMP)

The operating temperature of the power supply can be monitored via a signal applied to the interface output.

### Temperature Alarm (TA)

If the device is in the critical range, a warning signal is applied to the interface.

### Over Temperature Thermal Shutdown (OT)

The device has a thermal monitoring: shutdown with automatic restart. The OT signal is applied to the interface.

### Fan Failure Monitoring (FF)

If it comes to a fan failure or blocking, a signal is applied to the interface. The speed signal of the fan is monitored. Thus, even a creeping fault is detected at an early stage and there is a warning long sold separately in front of a fan failure.

### Digitale Interface (In preparation)

The standard equipment of the power supply is an analog interface. Optionally, the unit can be equipped on request with a digital interface. Options include either a RS485 interface or a TCP/IP interface.

### 3D-HD (3D Heat Dissipation)

Our aligned and controlled heat dissipation design opens possibilities that are formerly being reserved to custom design power supplies: Steplessly hard mount of the CPS-EX2000/3000 power supply modules in a 3D-room.

In practice that means that one can mount the modules into every angle imaginable. Our 3D heat dissipation (3D-HD) ensures optimal cooling in each mounting position you may consider.

### Technical Data Table

AC Input Range	184 – 265Vac					
AC Input Frequency	47 – 63Hz					
DC Input Range	250 – 350Vdc					
AC Nominal Voltage	230Vac <10A					
DC Nominal Voltage	250Vdc <9.3A 350Vdc <6.7A					
Model CPS-EX2000	.024	.036	.048	.072	.110	
DC Vout programmable	24-30Vdc	30-45Vdc	45-58Vdc	58-90Vdc	90-150Vc	
DC Cout programmable	42-84A	28-56A	21-42A	14-28A	9,1-18,2A	
Over Voltage OVP	35Vdc	52Vdc	68Vdc	105Vdc	175Vdc	
Ripple Noise 230Vac 20MHz	35mVpp	50mVpp	75mVpp	150mVpp	300mVpp	
Axiliary Voltage	12Vdc/0,5A accuracy $\pm 0,5V$ R&N 30mVpp, not influenced from SB, SD, INH operations					
Continuous Power P <sub>nom</sub>	184 – 265Vac, 2400W					
Power Density	8W / Cubic-Inch					
Cooling	Continuously controlled and monitored fans from EBM Papst (Germany)					
Efficiency	typ. 92 - 94% 230Vac at full load					
Power Factor Control (PFC)	0,99 / 230Vac full load					
Short Circuit Resistance	yes					
Open Circuit Protected	yes					
Base Load (OCP)	Non required (open circuit protected)					
Load Regulation	< $\pm 0,05\%$ 0-100%					
Load Regulation Time	<1ms on load switch 10-100%					
Rise Time and Latency	0V – Vout <sub>max</sub> , 15ms over all					
Accuracy	Ureg: $\leq \pm 0,5\%$ , Ireg: $\leq \pm 1\%$ , Umon: $\leq \pm 0,5\%$ , Imon: $\leq \pm 1\%$ , Uref: $\leq \pm 1\%$					
Temperature Control	yes, thermal shutdown & autorecovery (+70°C, outside measuring point distance 10mm)					
Hold Up Time	>20ms 230Vac mains buffering at full load					
Inrush Current	<14,6Aeff <20,7Apeak 230Vac active electronic inrush protection (no simple NTC)					
Startup Delay	typ. 1s					
Softstart	typ. 100ms					
Ambient Temperature	- 20°C...+60°C operating, derating 2,5%/°C >50°C					
Storage Temperature	- 40°C...+85°C					
Ambient Conditions	Humidity 95% non-condensing @ 25°C, climate class 3K3, pollution degree 2					
ROHS	2011/65/EU conform					
REACH	EG No. 1907/2006 conform					
EMI	EN55022 conducted class B, radiated class A					
EMS	EN61000-6-2,3					
Safety	cUL60950 (design is conform = UL classified), IEC/EN60950-1, IEC/EN60204-1					
Safety Class I	VDE0805, VDE0100					
Isolation Input to Output	3000Vac					
Isolation Input to Case	2500Vac					
Isolation Output to Case	500Vdc , $\geq 60Vdc = 1200Vdc / \geq 150Vdc = 2100Vdc$					
MTBF (IEC61709)	419000h (Meantime Between Failures: statistic time between failures after repairs)					
MTTF (IEC61709)	146105h (Meantime To Failure: statistic time to ever fails)					
Dimensions (HxWxD)	84x126,4x444mm   3,3x5x17,5 Inch (without frontplate, note cable outlet in planning)					
Weight	4,4kg					
Input Power Connections	Neutrik NAC3FCA (locked by bajonett) included					
Output Power Connections	Brass-Powerbars with metric M8 thread, a touch protection is included					

### Programming Time Vout [ms]

Model CPS-EX2000	.012	.024	.036	.048	.072	.110	.220
Slew Rate 90-10%, 10/100% Load, [ms] typ.	tba	78/7,8	tba	52/5,3	tba	tba	39/3,9
Output Capacity, [mF] typ.	tba	21,6	tba	3,6	tba	tba	0,11

## Manual und Technical Details

### Analog Interface CON1 (Connector Model Weidmueller 1277320000 = included)

Pin	Name	Type	Function	Signal	Remarks
1	AC OK-1	Output	Closers, Signal AC OK	Relay	Potential-free
2	DC OK-1	Output	Closers, Signal DC OK	Relay	Potential-free
3	AC OK-2	Output	Center, Signal AC OK	Relay	Potential-free
4	DC OK-2	Output	Center, Signal DC OK	Relay	Potential-free
5	AC OK-3	Output	Break, Signal AC OK	Relay	Potential-free
6	DC OK-3	Output	Break, Signal DC OK	Relay	Potential-free
7	SB	Input	Control Signal Standby	Switch / Open Collector	
8	SD	Input	Control Signal Shutdown	Switch / Open Collector	
9	DGND	-	Digital Ground	-	
10	+12V AUX	Output	Auxiliary Voltage	12Vdc/0,5A ±0,5V 30mVpp	≤1000uF, O-Ring Diode
11	DGND	-	Digital Ground	-	
12	INH	Input	Control Signal Inhibit (Interlock)	Switch	

### Analog Interface CON2 (Connector Model Weidmueller 1277330000 = included)

Pin	Name	Type	Function	Signal	Remarks
1	DGND	-	Digital Ground	-	
2	TEMP	Output	Temperature Control	Voltage 10mV/°C	
3	DGND	-	Digital Ground	-	
4	NC	NC	Not Connected		No Function
5	DCF	Output	Signal DC Failure	Open Collector	
6	ACF	Output	Signal AC Failure	Open Collector	
7	FF	Output	Signal Fan Failure	Open Collector	
8	INH	Output	Signal Inhibit Active	Open Collector	
9	OT	Output	Signal Over Temperature	Open Collector	
10	TA	Output	Signal Temperature Alarm	Open Collector	Early warning
11	OCP	Output	Signal Over Current Protection	Open Collector	
12	CC	Output	Signal Constant Current Mode	Open Collector	
13	OVP	Output	Signal Over Voltage	Open Collector	
14	CV	Output	Signal Constant Voltage Mode	Open Collector	

### Analog Interface CON3 (Connector Model Weidmueller 1277340000 = included)

Pin	Name	Type	Function	Signal	Remarks
1	AGND	-	Analog Ground	-	
2	Imon	Output	Current Monitor	0-5Vdc / 5mA, 0-10Vdc / 5mA	
3	NC	NC	Not Connected		No Function
4	Umon	Output	Voltage Monitor	0-5Vdc / 5mA, 0-10Vdc / 5mA	
5	CS	I/O	Current Share Bus (CSB)	Parallel Operation	Bidirectional
6	Ireg-OUT	Output	Current Programming Slave	0-5V / 5mA	
7	AGND	-	Analog Ground	-	
8	Ureg-OUT	Output	Voltage Programming Slave	0-5V / 5mA	
9	AGND	-	Analog Ground	-	
10*	Iadj	Output	Potentiometer Connection Current		With external poti
11	Uref	Output	Reference Voltage	5,2Vdc / 5mA, 10,4Vdc / 5mA	
12*	Uadj	Output	Potentiometer Connection Voltage		With external poti
13	CS	I/O	Current Share Bus (CSB)	Parallel Operation	Bidirectional
14	Ireg-IN	Input	Current Programming	0-5V, 0-10V, 0-20mA, 4-20mA	
15	AGND	-	Analog Ground	-	
16	Ureg-IN	Input	Voltage Programming	0-5V, 0-10V, 0-20mA, 4-20mA	

### Analog Interface CON4 (Connector Model Weidmueller 1277290000 = included)

Pin	Name	Type	Function	Signal	Remarks
1	Sense -	Input	Sense Connection	-	2V / load line
2	Sense -	Input	Sense Connection	-	
3, 4			NC	-	Must not be connected
5, 6			NC	-	
7	Sense +	Input	Sense Connection	-	2V / load line
8	Sense +	Input	Sense Connection	-	

**PIN10/12\*** when no external control signal shall be used the device can be set with internal potentiometers. Please connect Pin10 with Pin14 and Pin12 with Pin16 to operate this mode.

Schematic of the internal circuits CON1 - 4

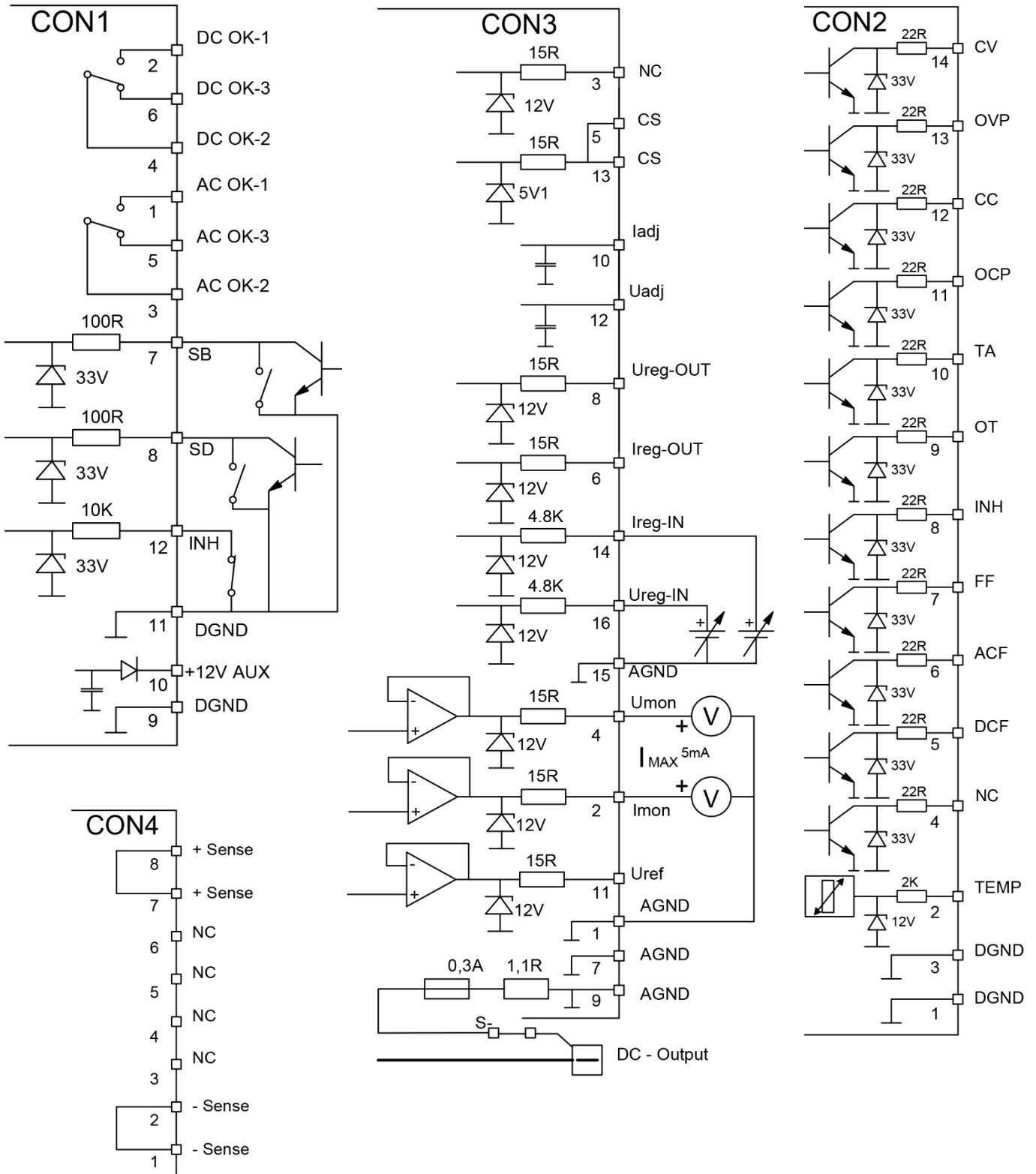

- Interface pluggable Push-Pull-Connectors from Weidmueller (included)
- Input Power Connector Neutrik NAC3FCA (included)
- Output Power Connection M8 Powerbars
- Lock-Pins snap into the 2U/3U 19" subrack

### REAR VIEW

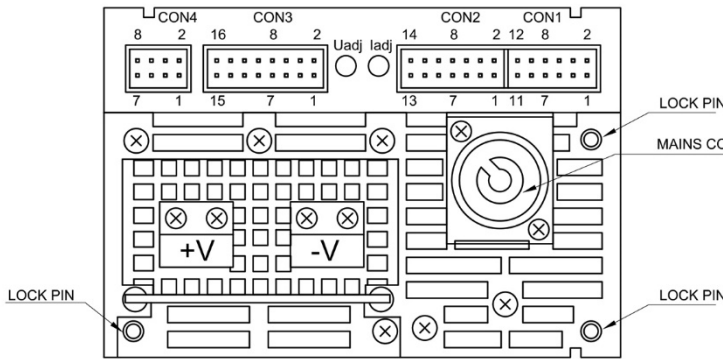

CON1	Push In	0,14-
CON2		1,5mm <sup>2</sup>
CON3		AWG26-16
CON4		
DC +/-	M8	200A/60°C
250Vac	Neutrik PowerCon®	3x2,5 mm <sup>2</sup>

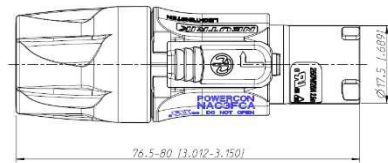

Neutrik NAC3FCA

#### A. OPERATING INSTRUCTION

##### IMPORTANT SAFETY INSTRUCTION:

The powerCON system is certified as connector without breaking capacity according IEC 61984 / VDE 0627.

In this standard the term connector (without breaking capacity) refers to components which in normal use are not to be engaged or disengaged when under load or live.

##### Connector Combination & Keyways:

With the two non-interchangeable types of connectors (A type and B type) it is impossible to produce a short circuit. Mating connectors (combination) are identified by mechanical keyways and by color.

##### A type (color coding blue) POWER IN

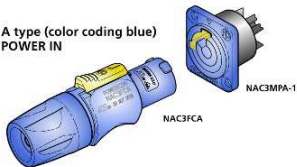

#### B. ASSEMBLY INSTRUCTION

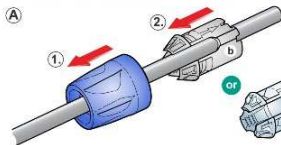

A Place the bushing (1) and the chuck (2) over the cable.

White chuck (a): 6.0 - 11.0 mm [0.236 - 0.433]  
 Black chuck (b): 9.5 - 15.0 mm [0.374 - 0.59"]  
 VDE: 9.5 - 14.0 mm [0.374 - 0.551"]

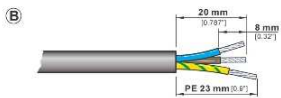

B Prepare the cable as shown.

Cable O.D.: 6.0 - 15.0 mm [0.236 - 0.59"]  
 Wire size: 2.5 mm<sup>2</sup> (AWG 14)

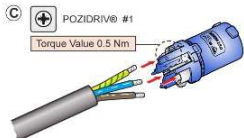

C Insert the wire into the terminals and fasten the clamping device with a POZIDRIV® #1, max. Torque 0.5 Nm (0.37 lb-ft).



#### Copy of the original instruction:

<http://www.neutrik.com/de/powercon/powercon-20-a/nac3fca>

D Slide the insert and the chuck (1) into the housing (2).

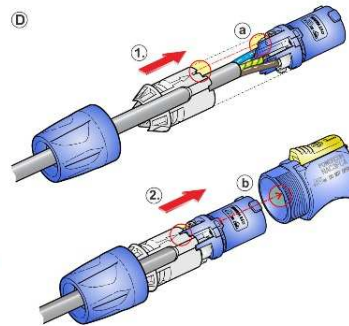

##### Important:

- (a) Align the chuck by positioning the nose into the recess.
- (b) Pay attention to the guiding keyway!

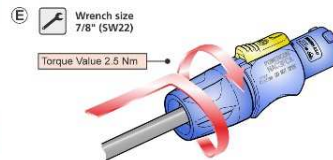

E Fasten bushing by means of a fork wrench 7/8" (SW 22), min. Torque 2.5 Nm (1.8 lb-ft).

FINISHED powerCON



### LED Operating Signal

CV/OVP	CV Constant Voltage Mode LED lights Green
	OVP Overvoltage maloperation or interference voltage LED lights Red
CC/OCP	CC Constant Current Mode LED lights Yellow
	OCP Over Current Protection LED flashes Red, also see >>Fuse Mode<<
TA/OT	TA Temperature Alarm LED lights Yellow, warning temperature shutdown pending
	OT Over Temperature Shutdown LED lights Red
INH/FF	INH Inhibit (Interlock) Shutdown LED lights Yellow
	FF Fan Failure LED lights Red
SD/SB	SD Shutdown LED lights Yellow
	SB Standby LED lights Red



### Configuration of the Analog Interface

Mode	S1	S2	S3	S4	S5	S6	S7	S8	S9	S10	S11	S12
0-5V	0	0	0	0	0	1	0	0	0	0		
0-10V	0	1	0	0	1	0	0	1	1	1		
0-20mA	1	1	0	1	1	0	0	1	1	1		
4-20mA	1	0	1	1	0	0	1	1	1	1		
CS active											0	
CS non-active											1	
Fuse Mode												0
Continuous Mode												1

**Warning!** CS (Current Share Mode) only applies, when a current distribution must take place while parallel operation mode. In single or parallel operation without the need of CS, always switch CS with S11 to OFF=1.  
**Factory set:** 0-10V Programming / CS non-active (S11=1), Continuous Mode (S12=1)

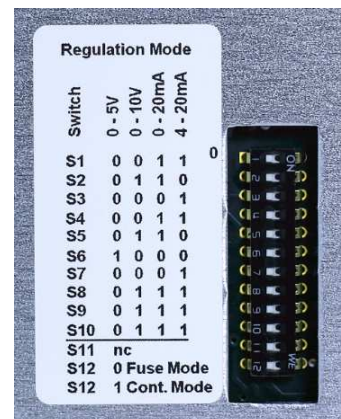

### Programming/Monitoring V/C Analog Interface (Ureg-IN/Ireg-IN) (Umon/Imon)

The standard programming of the CPS-EX Series is an analog interface. The output voltage is linearly proportional to the adjusted analog control signal.

The monitor signal is analog linear to the output voltage. The monitor signal for current and voltage is the real value that is measured directly at the output of the power supply. If a sense line is connected to compensate for the voltage drop across the load lines, the monitor signal is exactly the value that is measured at the connection point of the sense line. The description of the power supply in the sense operation is carried out in a separate section.

The analog inputs and outputs are non-floating. The mass is connected to the DC negative output.

The adapter provides the ability to select the desired input / output via a DIP switch. The burden of the control voltages is 1MΩ. The burden of the current interface is 500Ω. The latency to full compensation of V/C on the interface from 0-100% is 15ms for all CPS-EX models.

### Programming V/C via Potentiometer (Uadj/ladj) – Stand Alone Operation

The power supply is equipped with 2 potentiometers Uadj and ladj for setting voltage and current.

To enable the setting on the potentiometer, configure the interface via the DIP switch for 0-5V. Connect each Uadj and ladj of CON3 to the inputs Ureg-IN and I reg-IN. If one of the two potentiometer is not used, the other value can still be programmed via the interface. In such case, only the control signal 0-5V can be used.

### Fuse Mode

The Fuse Mode can be used mode to prevent a major damage to a defective load. Fuse Mode can be activated via the associated switch S12 DIP switch.

If the device is in the Fuse Mode (DIP switch S12=0), the device switches off when the constant current operation is taking longer than typ. 5s. The red OCP LED flashes with a period of 0,4s. The PSU is locked. The interlock can be canceled by the power supply is either switched off by the mains input, SB or SD contact for a moment.



### Continuous Mode

If you select Continuous Mode at DIP switch S12 (DIP switch S12=1), the device provides continuous power. It also applicable in the Constant Current Mode. Factory setup = Continuous Mode

### Over Load Behaviour

The CPS-EX changes from the standard operation mode into the high current mode when high and quick over load occurs. Thus it provokes a restart after a 30ms break and delivers continuous current to the output. This special behaviour is a protection for the power supply and for the connected load.

### Compensation of Load Line Drop Voltage (Sense +/-), standard operation mode

The CPS-EX power supply has a Sense Mode to compensate for the voltage drop over long load lines. The compensation amounts to a maximum of 2V per load line. Under certain circumstances, it can be expected to apply fairly more complicated external interference suppression. If sense is not used, CON4 Sense ++ and Sense -- shall necessarily be connected by short bridges to the power outputs (factory setup).

Sense operation: Remove the bridges between Sense ++, Sense -- and the power outputs. Connect the sense lines directly to the load. It is irrelevant which of the local connections Sense ++ and Sense -- are applied. Pay attention to the polarity of plus and minus of the load to prevent damage to the power supply. To avoid interference, twist the sense lines. In order to reduce inductive effects, we recommend that the load lines position is close to each other. In order to supply a pulsating load, the use of an electrolytic capacitor and a ceramic capacitor has proved. The internal Over Voltage Protection (OVP) of the power supply controls the DC power directly to the DC output terminals. In case of an error the OVP acts automatically (see OVP values corresponding table).

Operating in the sense mode requires that the maximum output voltage will not be exceeded. Maximum 2V per load lead can be compensated. The voltage drop in the load lines decreases the maximum output voltage rating. For example for a 30V unit: if the total voltage drop in the load leads is 2V you must subtract this value from the maximum programmable output voltage  $30V - 2V = 28V$  maximum available voltage at the load.

The sense terminals are directly connected to the power outputs.

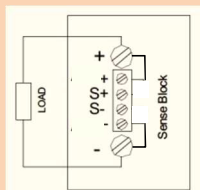

**Lokal Sensing**  
(factory setup)

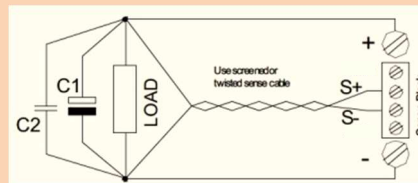

**Remote Sensing**  
(twisted sense lines)

### Compensation of Load Line Drop Voltage (Sense +/-) battery charger operation mode

#### Remote Sensing as a battery charger

If the CPS-EX power supply unit is used as a battery charger, it is recommended to refrain from sensing. It can lead to severe damage to the power supply, if the polarity of the sense line is confused (field experience: such error often occurs when system service is required, e.g. when the batteries are changed). If it is absolutely necessary to use sensing, proceed as described in the figure below. Proven approaches are 250mA for the fuses and 3...5A load capacity of diodes.

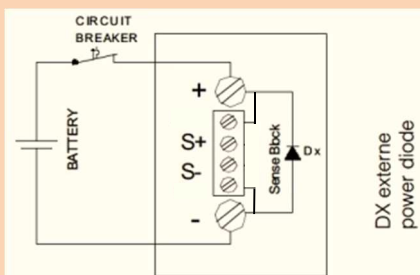

DX externe  
power diode

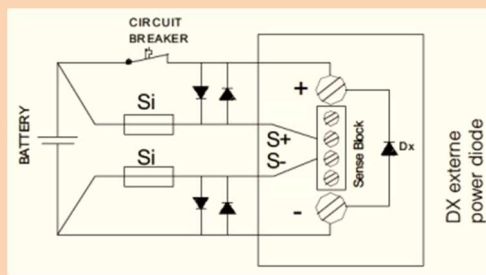

DX externe  
power diode

### Master-Slave Mode (Ureg-OUT/Ireg-OUT)

The CPS-EX power supplies offer the possibility of Master-Slave operation. To increase the output current, up to 5 units of the same type and output voltage can be connected in parallel. One device takes over the function of the master, the other devices assume the slave function. The Current Share Bus (CS) marries the involved power supplies together. The CS bus allows a symmetrical current distribution in parallel operation of several identical CPS-EX units.

Define the power supply as the master, which you want to address with your control. A coding of the power modules as the master or the slave is required (see below table). The signals of the interface are looped together. Connect Ureg-out and Ireg-out of the master to Ureg-in and Ireg-in from to slave. Connect the corresponding Ureg-out/Ireg-out from the slave to the next slave, etc. All the monitoring signals of each power supply are still available.

Master					
	0-5V	0-10V	0-20mA	4-20mA	Potis
S1	0	0	1	1	0
S2	0	1	1	0	0
S3	0	0	0	1	0
S4	0	0	1	1	0
S5	0	1	1	0	0
S6	1	0	0	0	1
S7	0	0	0	1	0
S8	0	1	1	1	0
S9	0	1	1	1	0
S10	0	1	1	1	0
S11	0	0	0	0	0
S12	1	1	1	1	1

Slave					
	0-5V	0-10V	0-20mA	4-20mA	Potis
S1	0	0	0	0	0
S2	0	0	0	0	0
S3	0	0	0	0	0
S4	0	0	0	0	0
S5	0	0	0	0	0
S6	1	1	1	1	1
S7	0	0	0	0	0
S8	0	1	1	1	0
S9	0	1	1	1	0
S10	0	1	1	1	0
S11	0	0	0	0	0
S12	1	1	1	1	1

### Current Distribution in Parallel Mode (CS), CSB Current Share Bus

In parallel operation, a uniform current distribution between the participating power supplies is important. To prevent one of the power supplies going early into the current limitation and display error message. An uneven load and thus premature aging of the participating devices is prevented.

Connect CON3 contact 5 (CS) to contact 13 of the slave. Are other devices involved in the parallel operation, you may grind the CS bus through from unit to unit. The current division between the devices will be performed automatically. The accuracy of the current distribution is  $\pm 10\%$ .

### External Shutdown (SD)

The power supply is set to the Shutdown mode, when the control input is either shorted via a relay contact, a switch contact or an NPN transistor with open collector (voltage drop  $< 1V$ , current typ. 1,5mA). Alternatively, a voltage of 10 to 30V (typ. 12V/1.5mA, 24V/5.5mA) can be applied.

If the shutdown repeats the power supply starts with a delay of 35ms.

Using the soft start the current and the voltage rises within 100ms continuously to the default set values. Between control input SD, power input and power output is a reinforced Isolation of max. 400Vdc.

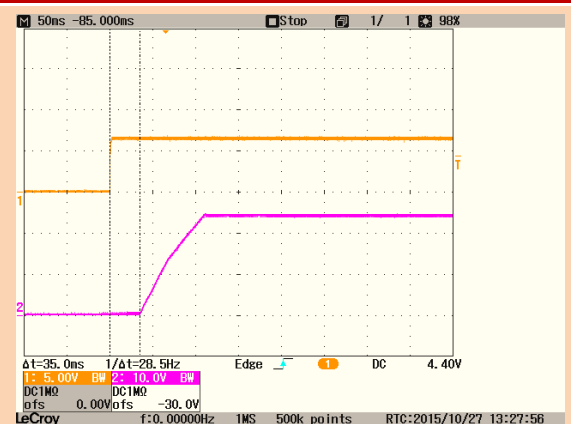

### Standby (SB)

The power supply is switched to standby mode when the control input is shorted optionally via a relay contact, a switch contact or an NPN transistor with open collector (voltage drop <math><1V</math>, current typ. 1.5mA). Alternatively, a voltage of 10 to 30V (typ. 12V/1.5mA, 24V/5.5mA) can be applied.

If the standby repeats, the power supply starts with a delay of 500ms.

Using the soft start the current and the voltage rises within 100ms continuously to the default set values. Between control input SB, power input and power output is a reinforced Isolation of max. 400Vdc.

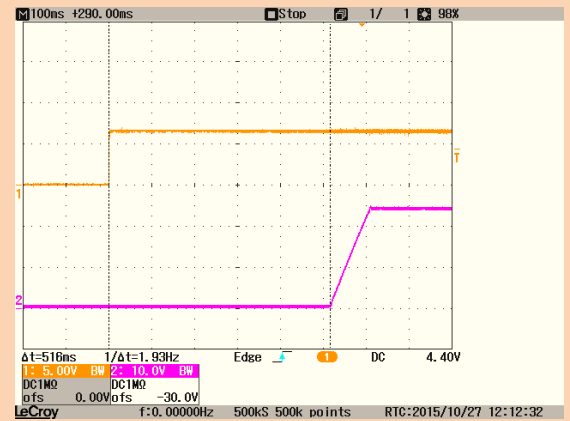

### Inhibit / Interlock (INH)

The power supply is equipped with a control input Inhibit (INH) to interlock a DC-shutdown of the power supply.

For the nominal operation of the power supply the connections of the control input "INH" must always be short-circuited. The power output is switched off as soon as the connection between the contacts of the control input INH is interrupted.

If Inhibit is repealed, the power supply starts with a delay of 35ms. Using the soft start the current and the voltage rises within 100ms continuously to the default set values. Between the INH contacts applies a current of typical 2mA.

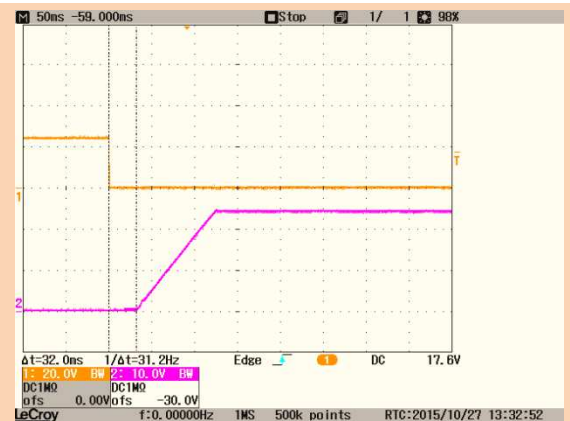

### ! Warning against damage in case of incorrect connection assignment

Never apply any external voltage to the control input INH. Never connect a resistor to the INH interface. Between control input INH, power input and power output is a reinforced Isolation of max. 400Vdc.

### Signal Inhibit (INH) Interlock

INH is high, as soon as the connection between the contacts of the control input INH is interrupted. Output Open Collector  $I_{MAX}=10mA$ ,  $V_{LOW}\leq 0,6V$ ,  $V_{MAX}=30V$ .

### Auxiliary Voltage +12V (AUX)

The power supply offers an auxiliary voltage 12V/500mA. The accuracy is  $\pm 500mV$ . Ripple & Noise 30mVpp. The auxiliary voltage is not affected by the control signals Standby (SB), Shutdown (SD) and Inhibit (INH) and remains always active. Between auxiliary voltage, power input and the power output is a reinforced Isolation max. 400Vdc.

### DC-OK Relay (DC Power Good)

The signal DC OK has potential-free relay contacts (changeover). The contacts of CON1 Pin2 and CON1 Pin4 are closed (relay coil is energized) when the power output is active. In (SD) shutdown mode, the contacts are closed.

The contacts CON1 Pin2 and CON1 Pin4 are open when the power output is inhibited by SB, INH, ACF, OT, FF, OVP or a defective PFC. Contact load (resistive load): 30Vdc/1A, 60Vdc/0.3A, 30Vac/0.5A. Between the intermediate relay contact, power input and the power output is a reinforced Isolation max. 400Vdc.

### DC Fail Signal (DCF)

DCF is high when the power output is disabled by SB, INH, ACF, OT, FF or OVP. While SD is active the message signal DCF is low. Output Open Collector  $I_{MAX}=10mA$ ,  $V_{LOW}\leq 0,6V$ ,  $V_{MAX}=30V$ .

### AC-OK Relay (AC Power Good)

The Power Good relay reports whether the input voltage is too low or missing. The notification signal AC OK is generated with potential-free relay contacts (changeover).

The contacts of CON1 Pin1 and CON1 Pin3 are closed (relay coil is energized) when the input voltage is higher than typ. 175Vac or 210Vdc (switch-on). The contacts of CON1 Pin5 and CON1 Pin3 are closed (relay coil is not energized) when the input voltage is lower than typical 165Vac or 145Vdc (turn-off). Contact load (resistive load): 30Vdc/1A, 60Vdc/0.3A, 30Vac/0.5A.

Between the relay contacts and the power input, and the output power is a reinforced isolation max. 400Vdc.

### AC Fail Signal (ACF)

The alarm signal ACF is high when the input voltage is lower than typ. 165Vac or 145Vdc.

The alarm signal ACF is low when the input voltage is higher than typ. 175Vac or 210Vdc.

Output Open Collector  $I_{MAX}=10mA$ ,  $V_{LOW}\leq 0,6V$ ,  $V_{MAX}=30V$ .

### Over Voltage Protection Signal (OVP)

If an over-voltage occurs to the output (for example, defective components, external feed voltage), it is followed by the shutdown of the power output. A periodic restart attempts (ticker operation period 1s) and a message is triggered: The alarm signal OVP is high.

Output Open Collector  $I_{MAX}=10mA$ ,  $V_{LOW}\leq 0,6V$ ,  $V_{MAX}=30V$ .

### Constant Voltage Mode (CV)

The signal CV is high when the power supply operates as a constant voltage source. Output Open Collector  $I_{MAX}=10mA$ ,  $V_{LOW}\leq 0,6V$ ,  $V_{MAX}=30V$ . When OVP, INH, SB, SD, FF, OCP or a defective PFC occur the message signal CV is low because the power output is switched off. The change between the CV and the CC mode is automatic. Please pay attention to the DIP switch setting of the Fuse Mode to avoid provoking malfunction.

### Constant Current Mode (CC)

The signal CC is high when the power supply operates as a constant current source. Output Open Collector  $I_{MAX}=10mA$ ,  $V_{LOW}\leq 0,6V$ ,  $V_{MAX}=30V$ . When OVP, INH, SB, SD, FF, OCP or defective PFC occur the message signal CC is low because the power output is switched off. The change between the CV and the CC mode is automatic. Please pay attention to the DIP switch setting of the Fuse Mode to avoid provoking malfunction.

### CC-Mode & Over Current Protection in the Fuse Mode (OCP)

The alarm signal OCP is high, when the constant current operation appears for more than typical 5s (Fuse Mode DIP switch S12=0).

Output Open Collector  $I_{MAX}=10mA$ ,  $V_{LOW}\leq 0,6V$ ,  $V_{MAX}=30V$ . By switching the unit on and off from SB, SD, or the mains, the power supply returns into operation.

The power output is switched off. The PFC and the fans are not switched off. In the SB or SD mode the message signal OCP is low. In the INH mode the status of the power supply does not change.

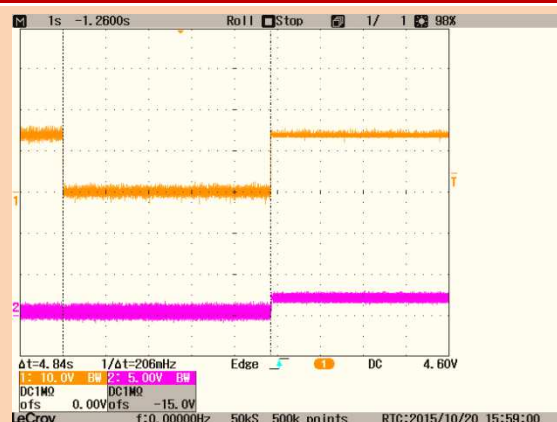

### Temperature Control Signal (TEMP)

The power supply has a temperature monitor. Here, the temperature of the power supply is continuously measured. The signal TEMP provides a voltage  $U_{TEMP}$  corresponding to the internal temperature of the power supply  $T_{INT}$ :  $T_{INT} = U_{TEMP} / (10\text{mV}/^\circ\text{C})$ ,  $U_{TEMP}$  in mV. Measuring range: +2...+150°C. Output impedance 2kOhm. Between the signal TEMP and the power input and the power output is a reinforced Isolation max. 400Vdc.

### Temperature Warning (TA)

The power supply has a Temperature Warning. The signal provides the user the option to save important data before the power supply shut down from OT, or to put his system in the emergency mode. The alarm signal TA is high when the internal temperature of the power supply is approximately 5°C below the overtemperature protection threshold. Output Open Collector  $I_{MAX} = 10\text{mA}$ ,  $V_{LOW} \leq 0,6\text{V}$ ,  $V_{MAX} = 30\text{V}$ .

### Over Temperature Shutdown (OT)

The alarm signal OT is high when the temperature of the power supply is higher than the over-temperature protection threshold. Output Open Collector  $I_{MAX} = 10\text{mA}$ ,  $V_{LOW} \leq 0,6\text{V}$ ,  $V_{MAX} = 30\text{V}$ .

### Fan Fail Signal (FF)

The power supply fans are continuously monitored. FF occurs when one or both fans have an error (lower speed due to bearing contamination, blockage or failures). A failure message is sent: The status signal FF applies high. Output Open Collector  $I_{MAX} = 10\text{mA}$ ,  $V_{LOW} \leq 0,6\text{V}$ ,  $V_{MAX} = 30\text{V}$ .

### C/V Chart and Operating Point

The output voltage set  $V_{out}$  is always linear proportional to the control signal  $U_{reg}$ .

The desired control signal is selected via the DIP switch:  
0-5V, 0-10V, 0-20mA oder 4-20mA.

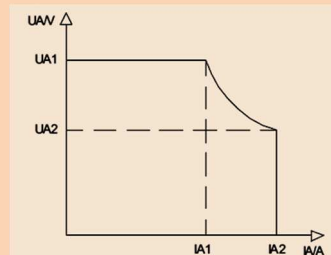

Model	Value UA1 (V)	Value IA1 (A)	Value UA2 (V)	Value IA2 (A)	Pmax (IA1/IA2)
CPS-EX2000.024	30Vdc	66,7A	24Vdc	84A	2001/2016W
CPS-EX2000.036	45Vdc	44,4A	36Vdc	56A	1998/2016W
CPS-EX2000.048	58Vdc	34,5A	48Vdc	42A	2001/2016W
CPS-EX2000.072	90Vdc	22,2A	72Vdc	28A	1998/2016W
CPS-EX2000.110	150Vdc	13,4A	110Vdc	18,2A	2010/2002W

### Inrush Current Limiter (electronic)

The power supply unit has an electronic current limiter (230Vac=14,6A<sub>rms</sub>/20,7A<sub>peak</sub>).

It is a precisely working circuit instead of a usual simple NTC solution. The accuracy is ±10%, regardless of the operating temperature and the duty cycles (interval ≥10s). We recommend the smallest circuit breaker a characteristic B with 16A.

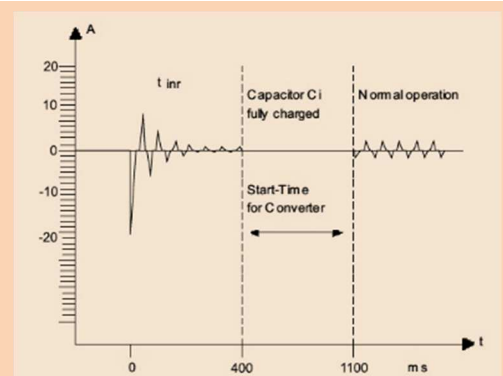
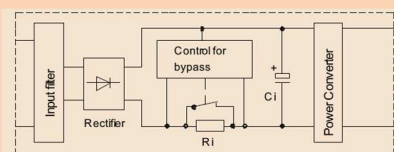

### Temperature Monitoring & Derating

The maximum ambient temperature during operation is +60°C. If the overtemperature protection is activated, the power supply but not the fan is switched off.

The measuring point is 10mm outside the power supply. The power supply unit starts automatically when it has cooled down.

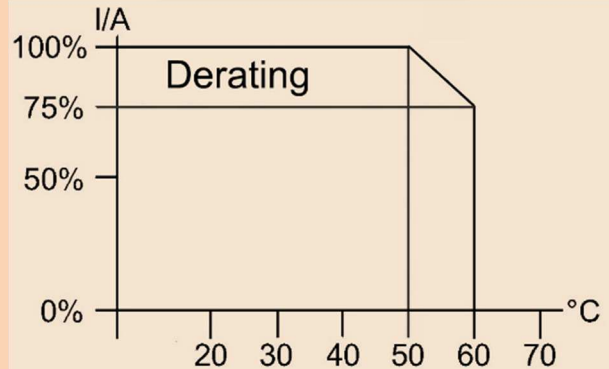

### Open Collector Circuit Interface

Z3.3

Between all open collector outputs and the power input and the power output is a reinforced Insulation of max. 400Vdc.

(Note: this applies to all signals from CON1 and CON2, regardless of whether they are designed as open collector, or not)

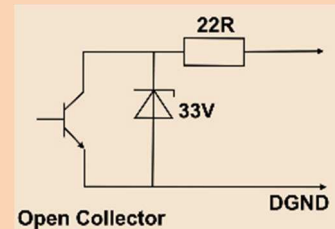

### Series Operation

Two or more units of the same model and output voltage can be operated up to a total voltage of 600Vdc in series. Due to the dielectric strength of the internal components used, only the models with an output voltage of 90Vdc and later are approved for series operation. Other power supplies are not approved for series operation above 60Vdc.

If the units are remotely controlled via the analog interface it is compulsory to use a potential-free control voltage!

### Parallel Operation & N+1 Decoupling

In order to increase the overall power of the power supply, two or more devices of the same model with the same output voltage may be operated in parallel. We recommend using a busbar for the DC power connector. Make sure that the cable lengths and cable cross-sections of all power supplies to the busbar or to the star point are identical. If you want to use the sensing function, connect it also to the star point or busbar. To avoid measurement errors, select the line length from the neutral point or from the busbar to the load as short as possible and use the maximum possible conductor cross-section.

The CPS-EX models have no internal O-ring diode, to operate the devices N+1 redundant.

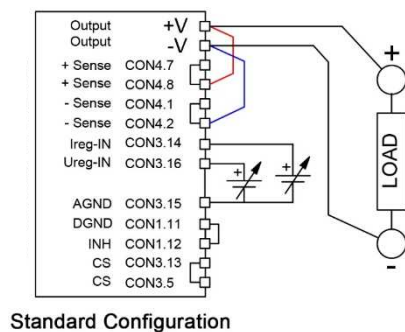

Standard Configuration

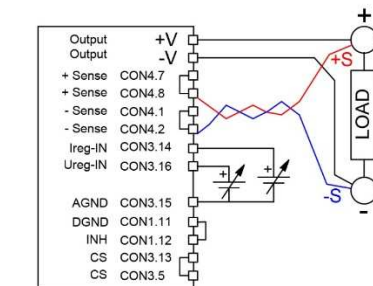

Remote Sense Configuration

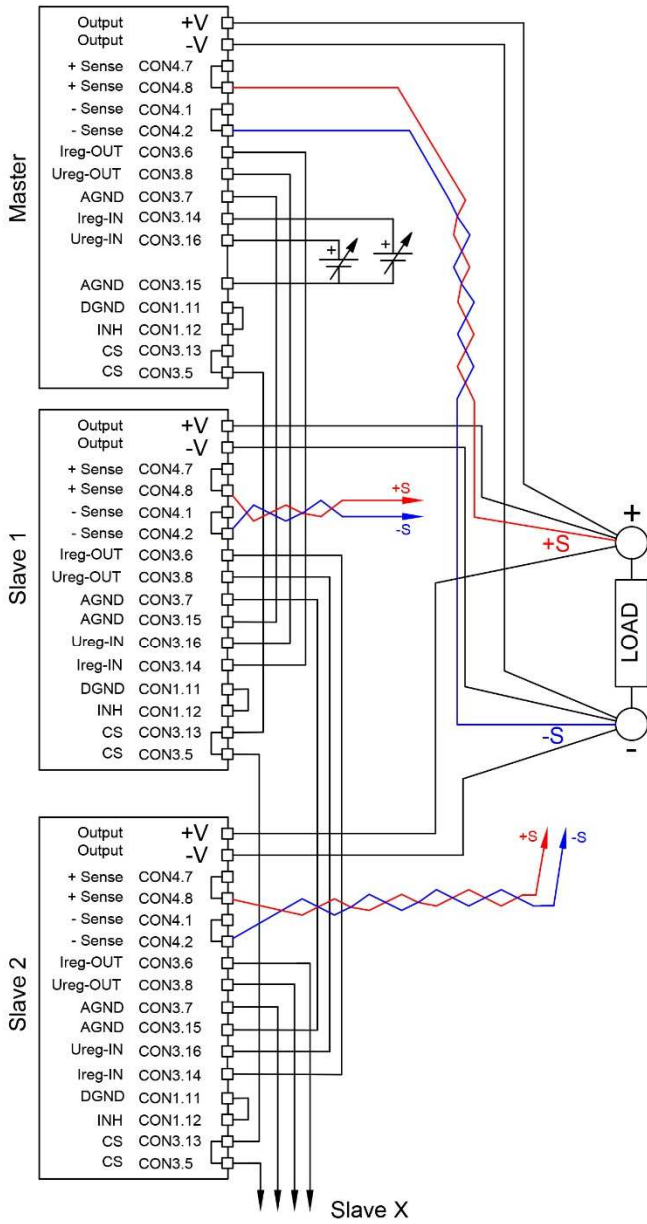

Parallel Master - Slave Operation

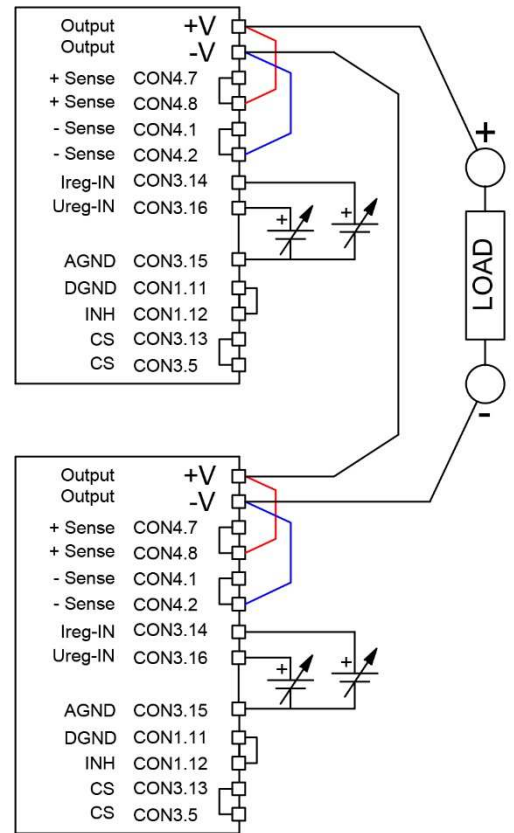

Series Operation

### Electrical Safety (Factory-Test / Fieldtest Owner)

	T	A	B	C <sup>1)</sup>	D
Type Test	60s	2500Vac	3000Vac	500Vdc	3000Vac
Factory Test	5s	2000Vac	2000Vac	500Vdc	1000Vdc
Field Test	2s	2000Vac	2000Vac	500Vdc	1000Vdc

<sup>1)</sup>  $\geq 60Vdc = 1200Vdc / \geq 150Vdc = 2100Vdc$

Type and Factorytest are the manufacturer. While repeating test, damage can occur to the power supply unit. For the Fieldtest (owner) follow the below instruction:

- Use suitable test equipment, raising the voltage slowly
- Short circuit L1 and N, and all the DC output terminals.
- Use only test voltages of 50/60Hz. The outputs are unearthed and therefore they have no resistance to GND/PE.
- If the residual voltage is  $\geq 60Vdc$ , observe the safety standards. Use only specially insulated screwdriver to trim the Ua/la.

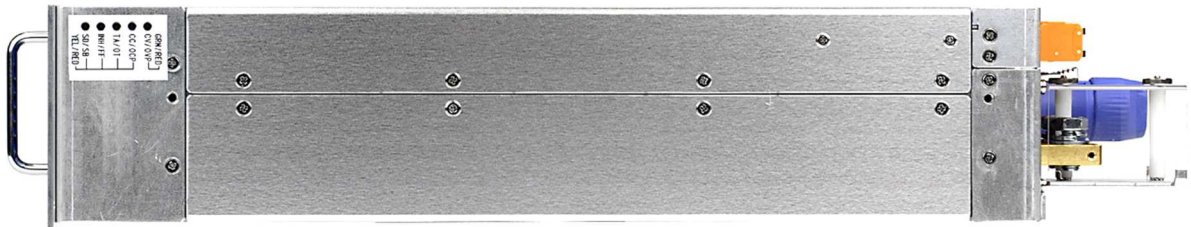
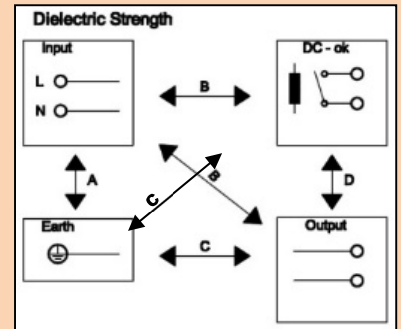



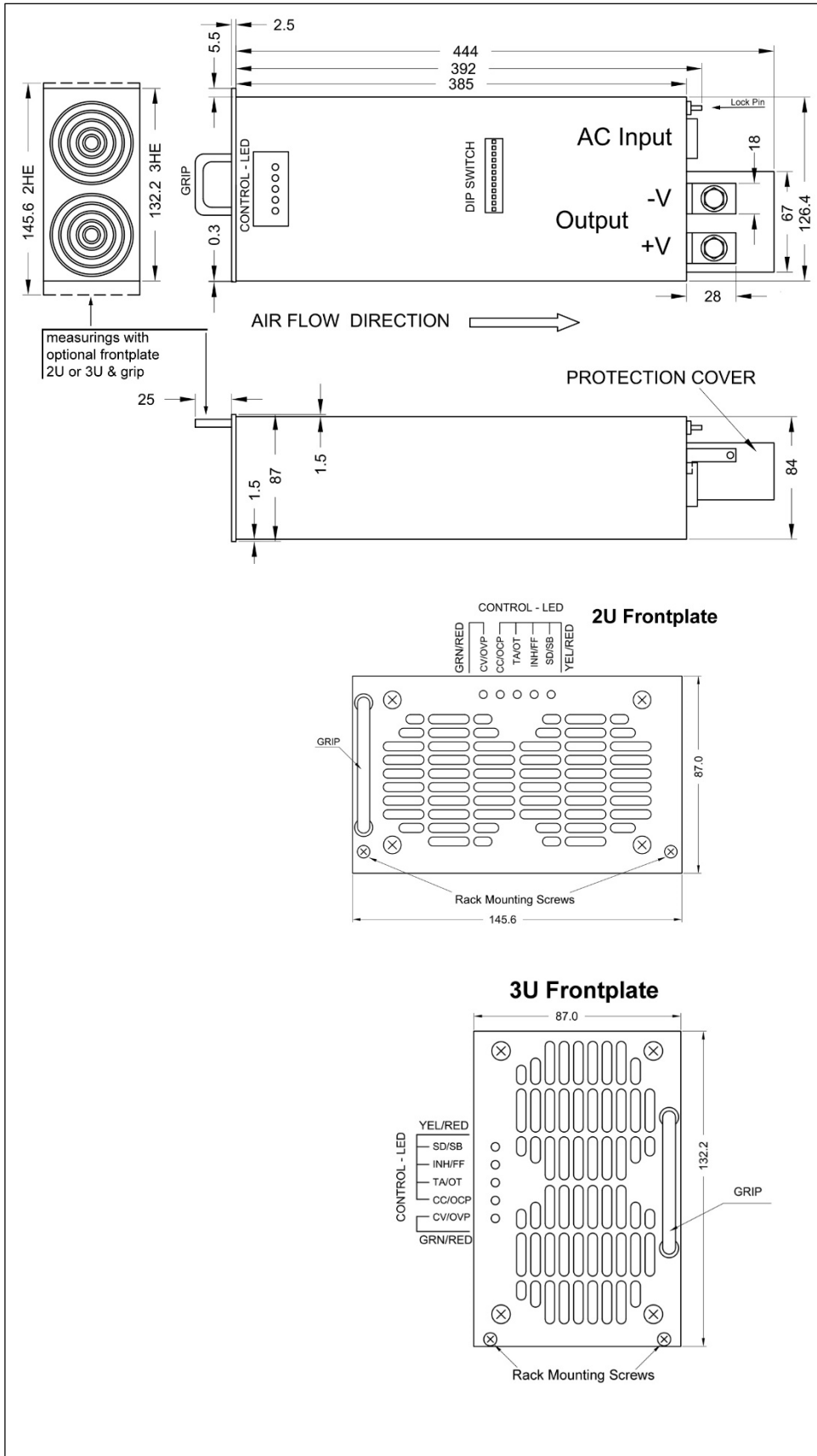

### Mechanics

Aluminium-housing IP20.

Cooling is achieved via front-to-rear fans.

In order to ensure adequate heat dissipation, 50mm to the front and 150mm blockade-free distance from the device back wall must be guaranteed.

The harnesses are to be designed and installed to that the air outlet of the unit is not being blocked.

In a rack mounting of multiple subracks, the rear distance of the cable-management increases, depending on the type of the air duct.

An optional cable-accession assistance for the racks will be available soon.

**19" 48TE Subrack 2U & 3U**

2U Subrack 48TE for 1-3 CPS-EX2000 or CPS-EX2000 with up to 9kW continuous power  
 3U Subrack 48TE for 1-5 CPS-EX2000 or CPS-EX2000 with up to 15kW continuous power

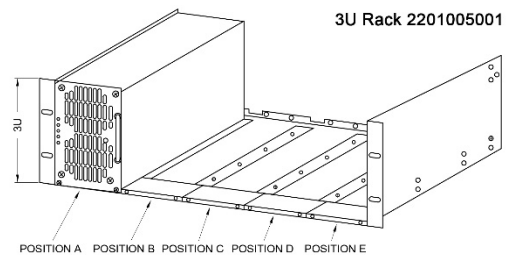
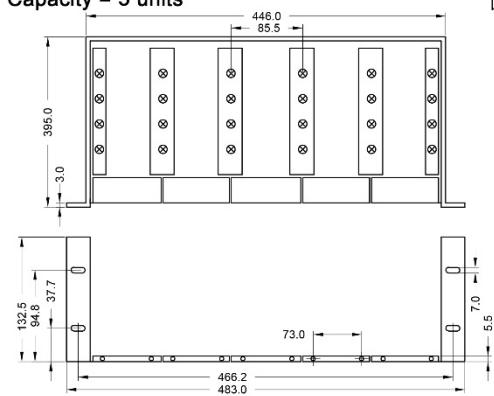
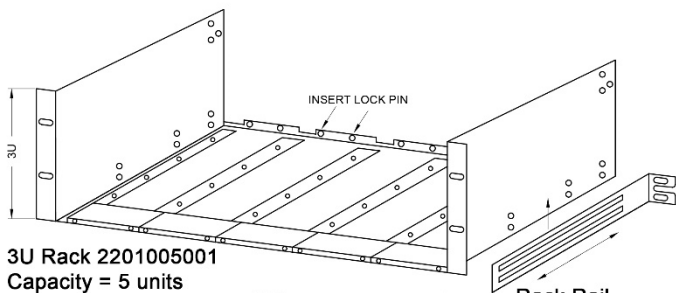
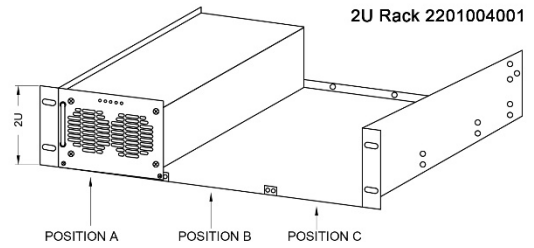
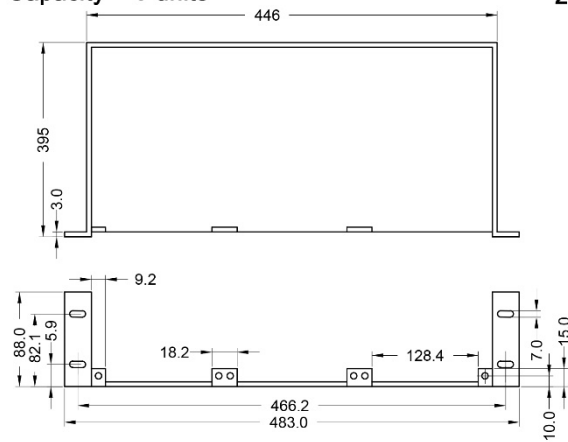
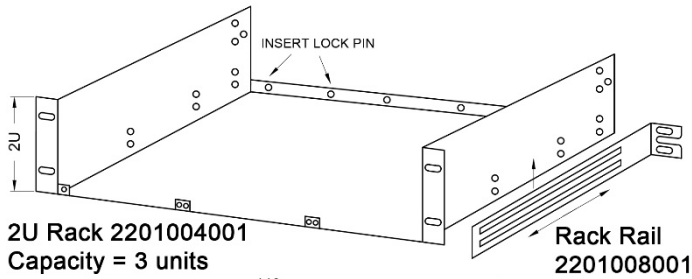

### Wall Mount Option & 3D Heat Dissipation (3D-HD)

Our aligned and controlled heat dissipation design opens possibilities that are formerly being reserved to custom design power supplies: Steplessly hard mount of the CPS-EX2000/3000 power supply modules in a 3D-room.

In practice that means that one can mount the modules into every angle imaginable. Our **3D Heat Dissipation (3D-HD)** ensures optimal cooling in each mounting position you may consider.

All you may consider is to make sure, that at least a distance of 5cm (2 Inch) to the front cooling slots and 15cm (6 Inch) to the back cooling slots are guaranteed to prevent from blocking the airflow. The cabling must also not block the heat dissipation.

When the CPS-EX2000/3000 is hard mounted the optional front plates cannot be used. The standard control LEDs allow visualization from any mounting position (see below drawing).

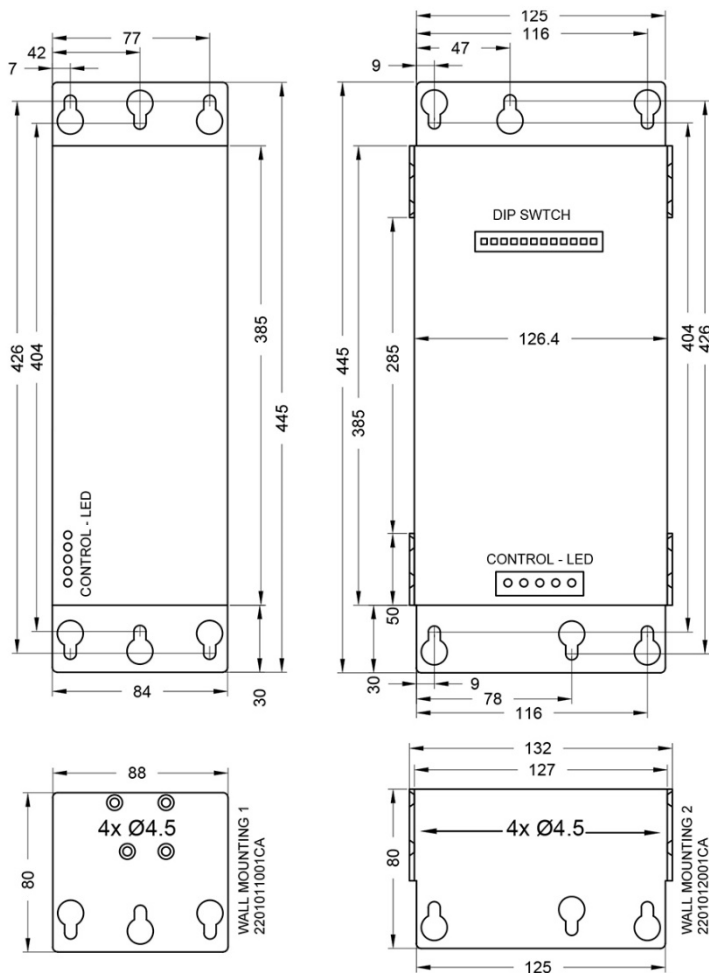

Straight Hardmount

Flat Hardmount

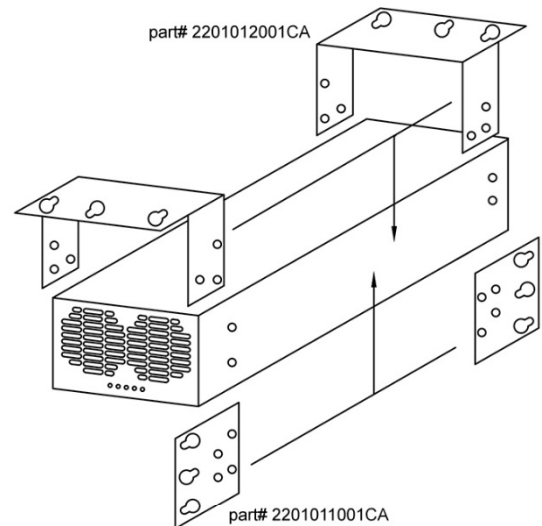

**WARNING:**

Only use the M4x10mm countersunk screws included into the mounting kit to prevent damage to the power supply unit.

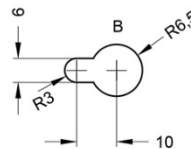

### Ordering Codes

Term	Information	Camtec Article Number
CPS-EX2000.024	24Vdc	3041110002CA
CPS-EX2000.036	36Vdc	3041110003CA
CPS-EX2000.048	48Vdc	3041110004CA
CPS-EX2000.072	72Vdc	3041110005CA
CPS-EX2000.110	110Vdc	3041110006CA
TCP/IP Interface	Including i.Drive Software Download	In preparation
19" Frontplate 2U	Including mounting material	2201006001CA
19" Frontplate 3U	Including mounting material	2201007001CA
19" Blindplate 2U	Including mounting material	2201009001CA
19" Blindplate 3U	Including mounting material	2201010001CA
19" Subrack 2U 84TE	3 Modules mountable only in conjunction with front panel 2U orderable	2201004001CA
19" Subrack 3U 84TE	5 Modules mountable only in conjunction with front panel 3U orderable	2201005001CA
19" Rack-Rail	2x Support Rails for rack mount, mounting kit included	2201008001CA
Cable Management Rail	Cable support for rack mount, mounting kit included	In preparation
Hard Mount Holder strait	2x Holder for strait wall mount, mounting kit included	2201011001CA
Hard Mount Holder flat	2x Holder for flat wall mount, mounting kit included	2201012001CA
Cooling System Flange	Front/Rear Flange for cooling system, mounting kit included, only for wall mounting!	In preparation

**Safety regulations: Please read these instructions completely before using the equipment. Keep these instructions on to hand. The device may only be operated by trained specialist staff.**

#### Installation:

- 1) The device is designed for devices and systems that meet the standard requirements for hazardous voltages, power and fire prevention.
- 2.) Installation and service only by trained persons. The AC power must be switched off. The work is to be labeled; accidental reconnection of the system must be prevented.
- 3.) Opening the device, its modification, loosening bolts or operation outside the specified herein specification or in an unsuitable environment, has the immediate loss of warranty to follow. We disclaim any responsibility for any resulting damage to persons or things.
- 4.) Note: The device must not be operated without an upstream circuit breaker (CB). We recommend the use of B-Type 16A. It is prohibited to use the unit without PE. It may be necessary upstream device has a power switch.

#### Warning:

**Non-compliance can result in fire and serious injury or death.**

1. Operate the appliance without PE connection.
2. Before connecting the device to the AC network, make wires free of voltage and assure accidentally switch on.
3. Allow neat and professional cabling.
4. Never open nor try to repair the unit. Inside are dangerous voltages that can cause electrical shock hazard.
5. Avoid metal pieces or other conductive material to fall into the item
6. Do not operate the device in damp or wet conditions
7. Do not operate the unit under EX-conditions



All parameters after 15 minutes of continuous operation at full load / 25°C / 230Vac 50/60Hz, unless otherwise indicated.